

G FORCE GC301 GYRO



Thank you for purchasing GFORCE GC301-Gyro for RC Cars. It is a device using gyro sensor and software algorithm to adjust steering output, providing you with a more stable and controlled driving experience.

FEATURES

• Make corrective steering adjustment for RC cars

GC301 gyro allows you to drive the RC car toward a given direction and taking precision turns at high speeds more manageable, more controllable and more stability.

• Remote gain function

You can adjust gain from the transmitter CH3 by using the remote gain function. Gain can also be adjusted with the trimmer on the GC301.

• Integrated, compact, and light weight

Compact size(21x21x11mm) and light weight(3.6g) realized by high density mounting technology.

CONNECTION

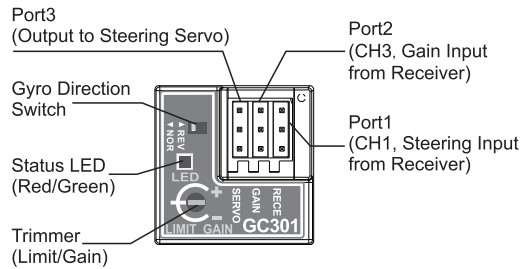

Status of LED Display

Status	Red LED	Green LED
Power Up	Fast Blink	Fast Blink
Ready	ON	OFF
Turn	ON	Fast Blink

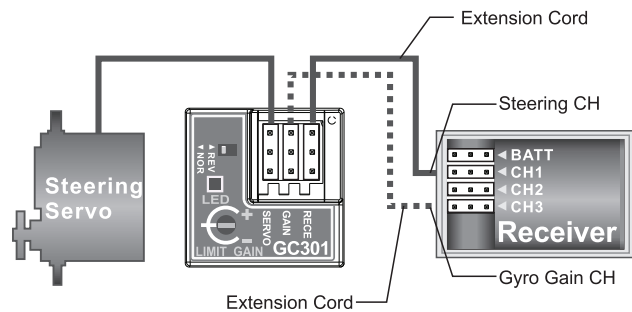

• Port2 Connect To Receiver

Remote gain effective and Trimmer become LIMIT.

• Port2 Not Connect To Receiver

Remote gain not effective and Trimmer become GAIN.

MOUNTING GYRO IN VEHICLE

Use double-sided sponge tape to mount the gyro in vehicle (do not use CA glue). The direction of rotation fixed by the gyro can be any direction within 360° relative to the steering axis controlled by the gyro.

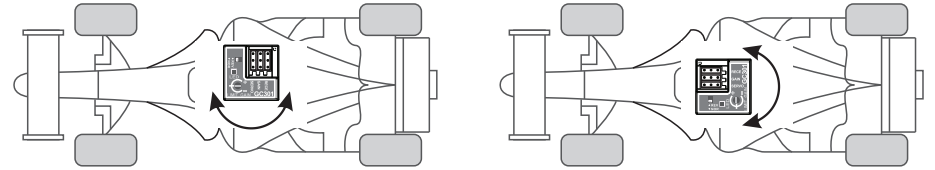

GYRO EFFECT (HEADING HOLD)

GC301 Gyro allows you to drive faster with the confidence of complete maneuver. The Gyro's heading hold effect manages steering output by automatically keeping the car's tires aligned in the direction you chose. It will also precisely maintain car direction regardless of the amount of traction of the track or outside force apply to the car. With heading hold, the car is more maneuverable and controllable.

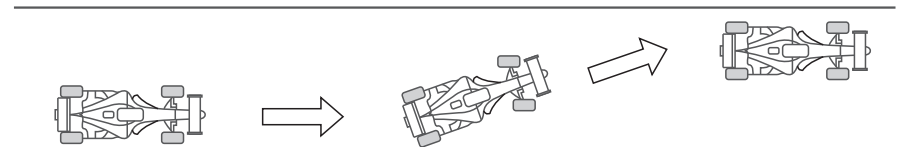

With GC301 Gyro for RC Car

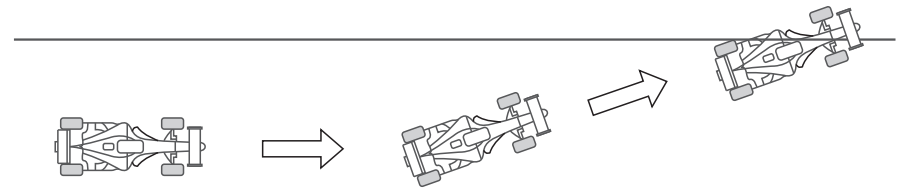

Without GC301 Gyro

GAIN ADJUSTMENT USING TRANSMITTER

Turn on your transmitter's power and turn on receiver. The GC301 requires 3-5 seconds to initialize when the power is turned on. Do not move the car and do not move the steering wheel during this initialization or the gyro may not initialize properly. Once the initialization process has been completed, the red LED will turn on.

You can adjust gain from the transmitter CH3 by using the remote gain function.

LIMIT TRIMMER ADJUSTMENTS

When the port2 of gyro and gain CH of the receiver are connected. The trimmer is automatically change to steering limit. Move the steering wheel to the left and right and perform adjustment at the limit trimmer so that the servo operation angle becomes the maximum value at which the servo horn does not strike the linkage.

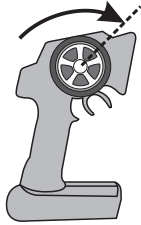

Steering wheel right to full

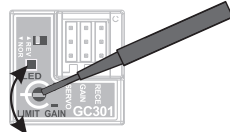

Limit trimmer adjustments

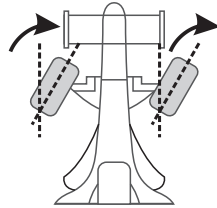

It adjusts to the maximum operation of linkage.

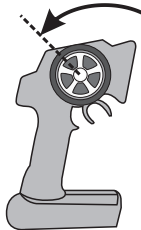

Steering wheel left to full

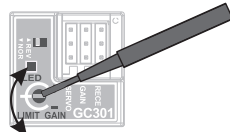

Limit trimmer adjustments

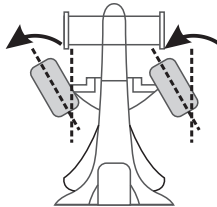

It adjusts to the maximum operation of linkage.

GYRO DIRECTION SWITCH

You can used gyro direction switch to adjust gyro operating direction. Turn the car all the way to the right, the steering will move all the way to the left. Be sure to set gyro operating direction correctly or the car will not run.

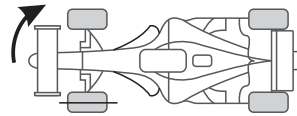

Turn the car to the right

Adjust switch if steering and car move in same direction

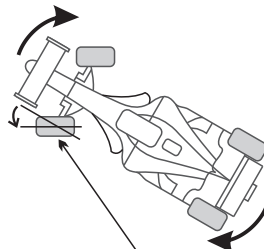
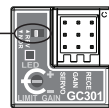

Steering moves to left

ADJUST GYRO SENSITIVITY WITH THE TRIMMER

When remote gain function is off, you can adjust gyro sensitivity with the gyro trimmer.

If the port 2 of gyro is not connected, remote gain is automatically disable. In this case, the limit trimmer is automatically changed to gyro sensitivity setting trimmer.

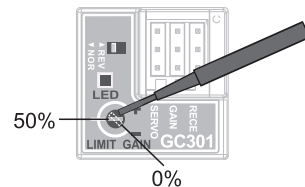

SPECIFICATION

- Gyro Sensor: Vibration Structure Gyro
- Operating Voltage: 4-8.4V
- Current Drain: 25mA
- Operating Temperature Range: -10°C to +45°C
- Dimensions: 21.0 x 21.0 x 11.0mm
- Weight: 3.6g



Products by
G-FORCE, Inc.

Mare-kanda Bld.9F, 1-3-1, Kajicho, Chiyoda-ku,
Tokyo, 101-0044, JAPAN

Copyright © 2014 G FORCE, Inc. All Right Reserved.

Ver1.11